

# Bảng thông số sản phẩm

Thông số kỹ thuật



## variable speed drive, Altivar Process ATV600, ATV630, 200kW, 380 to 440V, IP21

ATV630C20N4F

### Main

Range of product	Altivar Process ATV600
Product or component type	Variable speed drive
Product specific application	Process and utilities
Device short name	ATV630
Variant	Standard version
Product destination	Asynchronous motors Synchronous motors
EMC filter	Integrated with 150 m conforming to IEC 61800-3 category C3
IP degree of protection	IP21 conforming to IEC 61800-5-1 IP21 conforming to IEC 60529
[Us] rated supply voltage	380...440 V
type of cooling	Forced convection
Supply frequency	50...60 Hz - 5...5 %
[Us] rated supply voltage	380...440 V - 15...10 %
Motor power kW	200 kW (normal duty) 160 kW (heavy duty)
Line current	319 A at 400 V (normal duty) 262 A at 400 V (heavy duty) 369 A at 380 V (normal duty) 302 A at 380 V (heavy duty)
Prospective line I <sub>sc</sub>	50 kA
Apparent power	243 kVA at 440 V (normal duty) 200 kVA at 440 V (heavy duty)
Continuous output current	370 A at 2.5 kHz for normal duty 302 A at 2.5 kHz for heavy duty
Asynchronous motor control profile	Variable torque standard Constant torque standard Optimized torque mode
Synchronous motor control profile	Permanent magnet motor Synchronous reluctance motor
Speed drive output frequency	0.1...500 Hz
Nominal switching frequency	2.5 kHz
Switching frequency	2.5...8 kHz with derating factor 2...8 kHz adjustable
Safety function	STO (safe torque off) SIL 3
Discrete input logic	16 preset speeds

<b>Communication port protocol</b>	Modbus TCP Modbus serial Ethernet
<b>Option card</b>	Slot A: communication module, Profibus DP V1 Slot A: communication module, PROFINET Slot A: communication module, DeviceNet Slot A: communication module, Modbus TCP/EtherNet/IP Slot A: communication module, CANopen daisy chain RJ45 Slot A: communication module, CANopen SUB-D 9 Slot A: communication module, CANopen screw terminals Slot A/slot B: digital and analog I/O extension module Slot A/slot B: output relay extension module Slot A: communication module, Ethernet IP/Modbus TCP/MD-Link Communication module, BACnet MS/TP Communication module, Ethernet Powerlink

## Complementary

<b>Mounting mode</b>	Floor-standing
<b>Maximum transient current</b>	407 A during 60 s (normal duty) 453 A during 60 s (heavy duty)
<b>Network number of phases</b>	3 phases
<b>Discrete output number</b>	0
<b>Discrete output type</b>	Relay outputs R1A, R1B, R1C 250 V AC 3000 mA Relay outputs R1A, R1B, R1C 30 V DC 3000 mA Relay outputs R2A, R2C 250 V AC 5000 mA Relay outputs R2A, R2C 30 V DC 5000 mA Relay outputs R3A, R3C 250 V AC 5000 mA Relay outputs R3A, R3C 30 V DC 5000 mA
<b>Output voltage</b>	<= power supply voltage
<b>Permissible temporary current boost</b>	1.1 x I <sub>n</sub> during 60 s (normal duty) 1.5 x I <sub>n</sub> during 60 s (heavy duty)
<b>Motor slip compensation</b>	Not available in permanent magnet motor law Adjustable Automatic whatever the load Can be suppressed
<b>Acceleration and deceleration ramps</b>	Linear adjustable separately from 0.01...9999 s
<b>Physical interface</b>	Ethernet 2-wire RS 485
<b>Braking to standstill</b>	By DC injection
<b>Protection type</b>	Thermal protection: motor Safe torque off: motor Motor phase break: motor Thermal protection: drive Safe torque off: drive Overheating: drive Overcurrent between output phases and earth: drive Overload of output voltage: drive Short-circuit protection: drive Motor phase break: drive Overvoltages on the DC bus: drive Line supply overvoltage: drive Line supply undervoltage: drive Line supply phase loss: drive Overspeed: drive Break on the control circuit: drive
<b>Transmission rate</b>	10, 100 Mbits 4800 bps, 9600 bps, 19200 bps, 38.4 Kbps
<b>Frequency resolution</b>	Display unit: 0.1 Hz Analog input: 0.012/50 Hz
<b>Transmission frame</b>	RTU

<b>Electrical connection</b>	Control: removable screw terminals 0.5...1.5 mm <sup>2</sup> Line side: M12 bar - 2 cables 3 x 120 mm <sup>2</sup> minimum per phase (normal duty) Line side: M12 bar - 3 cables 3 x 70 mm <sup>2</sup> minimum per phase (normal duty) Line side: M12 bar - 3 cables 3 x 185 mm <sup>2</sup> maximum per phase (normal duty) Line side: M12 bar - 4 cables 3 x 120 mm <sup>2</sup> maximum per phase (normal duty) Motor: M12 bar - 2 cables 3 x 120 mm <sup>2</sup> minimum per phase (normal duty) Motor: M12 bar - 3 cables 3 x 70 mm <sup>2</sup> minimum per phase (normal duty) Motor: M12 bar - 3 cables 3 x 185 mm <sup>2</sup> maximum per phase (normal duty) Motor: M12 bar - 4 cables 3 x 120 mm <sup>2</sup> maximum per phase (normal duty) Line side: M12 bar - 2 cables 3 x 95 mm <sup>2</sup> minimum per phase (heavy duty) Line side: M12 bar - 3 cables 3 x 185 mm <sup>2</sup> maximum per phase (heavy duty) Line side: M12 bar - 4 cables 3 x 120 mm <sup>2</sup> maximum per phase (heavy duty) Motor: M12 bar - 1 cables 3 x 185 mm <sup>2</sup> minimum per phase (heavy duty) Motor: M12 bar - 2 cables 3 x 95 mm <sup>2</sup> minimum per phase (heavy duty) Motor: M12 bar - 3 cables 3 x 185 mm <sup>2</sup> maximum per phase (heavy duty) Motor: M12 bar - 4 cables 3 x 120 mm <sup>2</sup> maximum per phase (heavy duty)
<b>Connector type</b>	RJ45 (on the remote graphic terminal) for Ethernet/Modbus TCP RJ45 (on the remote graphic terminal) for Modbus serial
<b>Data format</b>	8 bits, configurable odd, even or no parity
<b>Type of polarization</b>	No impedance
<b>Exchange mode</b>	Half duplex, full duplex, autonegotiation Ethernet/Modbus TCP
<b>Number of addresses</b>	1...247 for Modbus serial
<b>Method of access</b>	Slave Modbus TCP
<b>Supply</b>	External supply for digital inputs: 24 V DC (19...30 V), <1.25 mA, protection type: overload and short-circuit protection Internal supply for reference potentiometer (1 to 10 kOhm): 10.5 V DC +/- 5 %, <10 mA, protection type: overload and short-circuit protection Internal supply for digital inputs and STO: 24 V DC (21...27 V), <200 mA, protection type: overload and short-circuit protection
<b>Local signalling</b>	3 LEDs for local diagnostic 3 LEDs (dual colour) for embedded communication status 4 LEDs (dual colour) for communication module status 1 LED (red) for presence of voltage
<b>Width</b>	600 mm
<b>Height</b>	2150 mm
<b>Depth</b>	605 mm
<b>Net weight</b>	480 kg
<b>Analogue input number</b>	3
<b>Analogue input type</b>	AI1, AI2, AI3 software-configurable voltage: 0...10 V DC, impedance: 31.5 kOhm, resolution 12 bits AI1, AI2, AI3 software-configurable current: 0...20 mA, impedance: 250 Ohm, resolution 12 bits AI2 voltage analog input: - 10...10 V DC, impedance: 31.5 kOhm, resolution 12 bits
<b>Discrete input number</b>	8
<b>Discrete input type</b>	DI7, DI8 programmable as pulse input: 0...30 kHz, 24 V DC (<= 30 V)
<b>Input compatibility</b>	DI1...DI6: discrete input level 1 PLC conforming to IEC 61131-2 DI5, DI6: discrete input level 1 PLC conforming to IEC 65A-68 STOA, STOB: discrete input level 1 PLC conforming to IEC 61131-2
<b>Discrete input logic</b>	Positive logic (source) (DI1...DI8), < 5 V (state 0), > 11 V (state 1) Negative logic (sink) (DI1...DI8), > 16 V (state 0), < 10 V (state 1)
<b>Analogue output number</b>	2
<b>Analogue output type</b>	Software-configurable voltage AQ1, AQ2: 0...10 V DC impedance 470 Ohm, resolution 10 bits Software-configurable current AQ1, AQ2: 0...20 mA, resolution 10 bits Software-configurable current DQ-, DQ+: 30 V DC Software-configurable current DQ-, DQ+: 100 mA

<b>Sampling duration</b>	2 ms +/- 0.5 ms (DI1...DI4) - discrete input 5 ms +/- 1 ms (DI5, DI6) - discrete input 5 ms +/- 0.1 ms (AI1, AI2, AI3) - analog input 10 ms +/- 1 ms (AO1) - analog output
<b>Accuracy</b>	+/- 0.6 % AI1, AI2, AI3 for a temperature variation 60 °C analog input +/- 1 % AO1, AO2 for a temperature variation 60 °C analog output
<b>Linearity error</b>	AI1, AI2, AI3: +/- 0.15 % of maximum value for analog input AO1, AO2: +/- 0.2 % for analog output
<b>Relay output number</b>	3
<b>Relay output type</b>	Configurable relay logic R1: fault relay NO/NC electrical durability 100000 cycles Configurable relay logic R2: sequence relay NO electrical durability 100000 cycles Configurable relay logic R3: sequence relay NO electrical durability 100000 cycles
<b>Refresh time</b>	Relay output (R1, R2, R3): 5 ms (+/- 0.5 ms)
<b>Minimum switching current</b>	Relay output R1, R2, R3: 5 mA at 24 V DC
<b>Maximum switching current</b>	Relay output R1, R2, R3 on resistive load, cos phi = 1: 3 A at 250 V AC Relay output R1, R2, R3 on resistive load, cos phi = 1: 3 A at 30 V DC Relay output R1, R2, R3 on inductive load, cos phi = 0.4 and L/R = 7 ms: 2 A at 250 V AC Relay output R1, R2, R3 on inductive load, cos phi = 0.4 and L/R = 7 ms: 2 A at 30 V DC
<b>Isolation</b>	Between power and control terminals
<b>Maximum output frequency</b>	500 kHz
<b>Maximum input current</b>	369.0 A
<b>Variable speed drive application selection</b>	Building - HVAC compressor centrifugal Food and beverage processing other application Mining mineral and metal fan Mining mineral and metal pump Oil and gas fan Water and waste water other application Building - HVAC screw compressor Food and beverage processing pump Food and beverage processing fan Food and beverage processing atomization Oil and gas electro submersible pump (ESP) Oil and gas water injection pump Oil and gas jet fuel pump Oil and gas compressor for refinery Water and waste water centrifuge pump Water and waste water positive displacement pump Water and waste water electro submersible pump (ESP) Water and waste water screw pump Water and waste water lobe compressor Water and waste water screw compressor Water and waste water compressor centrifugal Water and waste water fan Water and waste water conveyor Water and waste water mixer
<b>Motor power range AC-3</b>	110...220 kW at 380...440 V 3 phases
<b>Quantity per set</b>	1
<b>Enclosure mounting</b>	Floor-standing

## Environment

<b>Insulation resistance</b>	> 1 MOhm 500 V DC for 1 minute to earth
<b>Noise level</b>	70 dB conforming to 86/188/EEC
<b>Power dissipation in W</b>	4380 W, switching frequency 2.5 kHz (normal duty) 3380 W, switching frequency 2.5 kHz (heavy duty)
<b>Volume of cooling air</b>	1300 m3/h
<b>Operating position</b>	Vertical +/- 10 degree
<b>Maximum THDI</b>	<48 % full load conforming to IEC 61000-3-12

<b>Electromagnetic compatibility</b>	Electrostatic discharge immunity test level 3 conforming to IEC 61000-4-2 Radiated radio-frequency electromagnetic field immunity test level 3 conforming to IEC 61000-4-3 Electrical fast transient/burst immunity test level 4 conforming to IEC 61000-4-4 1.2/50 $\mu$ s - 8/20 $\mu$ s surge immunity test level 3 conforming to IEC 61000-4-5 Conducted radio-frequency immunity test level 3 conforming to IEC 61000-4-6
<b>Pollution degree</b>	2 conforming to IEC 61800-5-1
<b>Vibration resistance</b>	1.5 mm peak to peak (f= 2...13 Hz) conforming to IEC 60068-2-6 1 gn (f= 13...200 Hz) conforming to IEC 60068-2-6
<b>Shock resistance</b>	15 gn for 11 ms conforming to IEC 60068-2-27
<b>Relative humidity</b>	5...95 % without condensation conforming to IEC 60068-2-3
<b>Ambient air temperature for operation</b>	-15...40 °C (without derating) 40...50 °C (with derating factor)
<b>Ambient air temperature for storage</b>	-40...70 °C
<b>Operating altitude</b>	<= 1000 m without derating 1000...4800 m with current derating 1 % per 100 m
<b>Product certifications</b>	ATEX EAC C-Tick
<b>Marking</b>	CE
<b>Standards</b>	IEC 60204-1 IEC 61800-2 IEC 61800-3 IEC 61800-5-1
<b>Overvoltage category</b>	III
<b>Regulation loop</b>	Adjustable PID regulator
<b>Noise level</b>	70 dB
<b>Pollution degree</b>	2

## Packing Units

<b>Unit Type of Package 1</b>	PCE
<b>Number of Units in Package 1</b>	1
<b>Package 1 Height</b>	258.0 cm
<b>Package 1 Width</b>	85.0 cm
<b>Package 1 Length</b>	75.0 cm
<b>Package 1 Weight</b>	530.0 kg

## Environmental Data

Schneider Electric nhắm đến việc đạt được vị trí Net Zero vào năm 2050 thông qua các quan hệ đối tác chuỗi cung ứng, giảm vật liệu tác động và sự tuần hoàn thông qua chiến dịch "Use Better, Use Longer, Use Again" đang diễn ra của chúng tôi để kéo dài tuổi thọ sản phẩm và khả năng tái chế.

[Dữ liệu môi trường đã giải thích >](#)

[Cách chúng tôi đánh giá tính bền vững của sản phẩm >](#)

### Ảnh hưởng môi trường

Carbon footprint (kg.eq.CO2 per CR, Total Life cycle)	<b>155584</b>
---	---------------

Environmental Disclosure	<a href="#">Product Environmental Profile</a>
--------------------------	---

## Use Better

### Vật liệu và Bao bì

Packaging made with recycled cardboard	<b>No</b>
--	-----------

Packaging without single use plastic	<b>No</b>
--------------------------------------	-----------

EU RoHS Directive	<b>Pro-active compliance (Product out of EU RoHS legal scope)</b>
-------------------	---

REACH Regulation	<a href="#">REACH Declaration</a>
------------------	-----------------------------------

China RoHS Regulation	<a href="#">China RoHS declaration</a>
-----------------------	--

### Sử dụng năng lượng hiệu quả

Product contributes to saved and avoided emissions	<b>Yes</b>
--	------------

## Use Again

 **Đóng gói lại và tái sản xuất**

Circularity Profile

[End of Life Information](#)

WEEE



The product must be disposed on European Union markets following specific waste collection and never end up in rubbish bins

Take-back

No

**Dimensions**

---

**Right and Front Views**

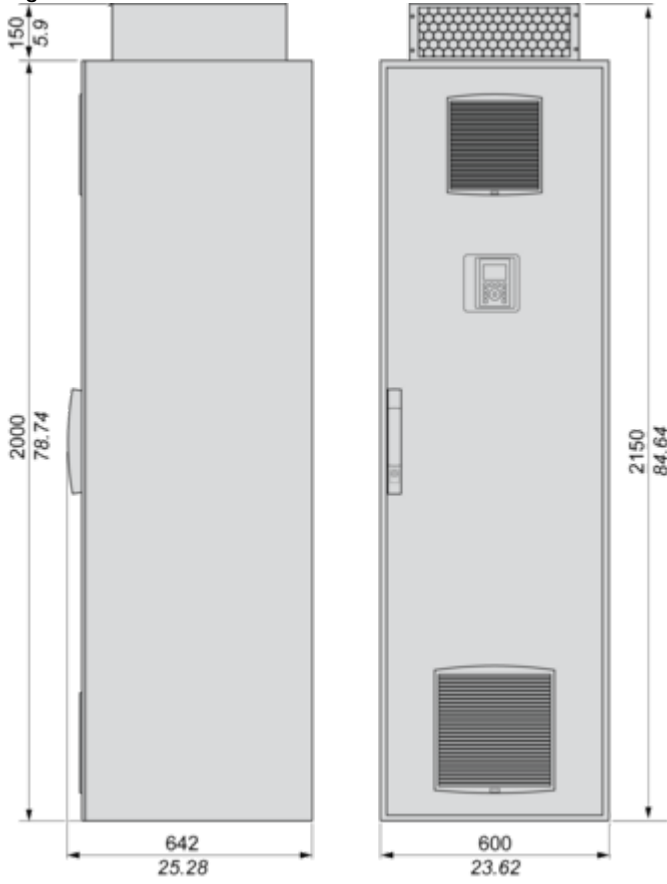



Mounting and Clearance

Clearances

---

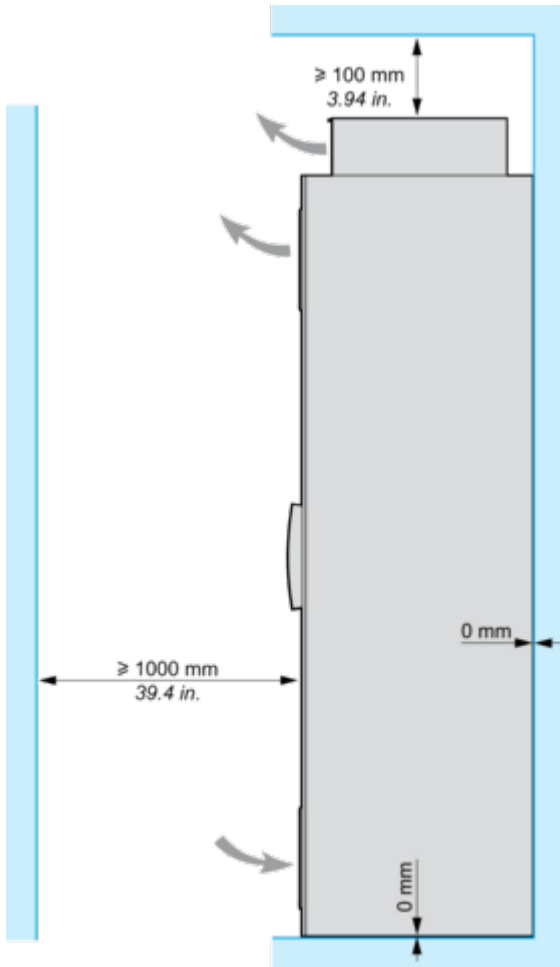

## Connections and Schema

### Floor Standing Drive Circuit Diagram

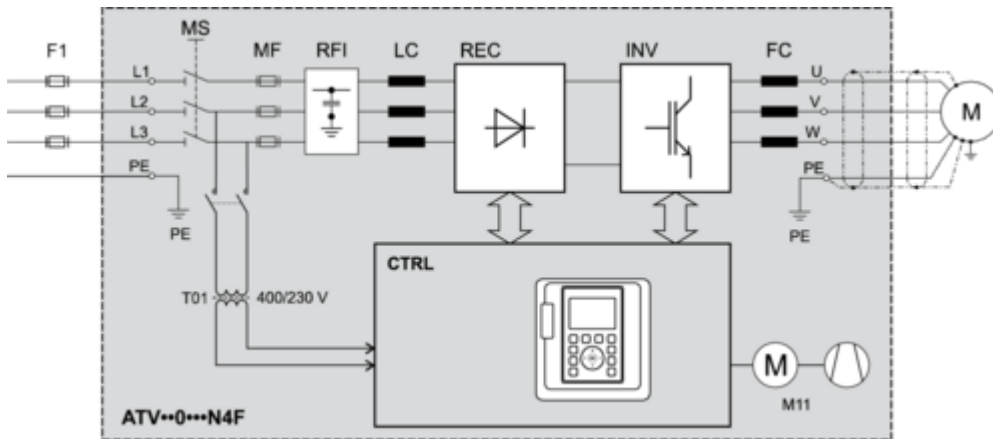

**F1** External pre-fuse or circuit breaker

**MS** Built-in main switch (only available on IP54 drives)

**T01** Control transformer 400 / 230 V AC

**MF** aR fuses

**RFI** Built-in RFI filter

**LC** Line reactor choke

**REC** Rectifier module

**INV** Inverter module

**FC** dv/dt filter (from 355 kW the dv/dt filter choke 150 m is built-in as standard)

**CTRL** Control panel

**M11** Fan in enclosure door

## Control Block Wiring Diagram

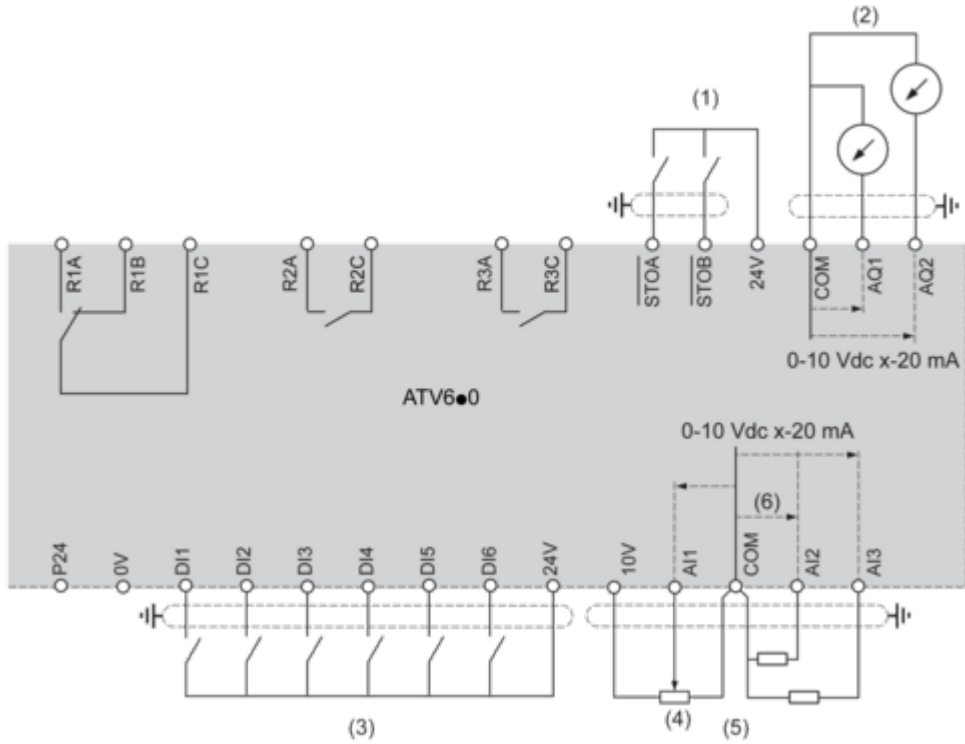

- (1) Safe Torque Off
- (2) Analog Output
- (3) Digital Input
- (4) Reference potentiometer
- (5) Analog Input
- R1A, R1B, R1C : Fault relay
- R2A, R2C : Sequence relay
- R3A, R3C : Sequence relay

### Sensor Connection

It is possible to connect either 1 or 3 sensors on terminals AI2 or AI3.

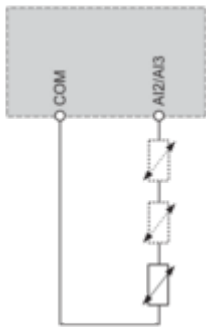

## Sink / Source Switch Configuration

The switch is used to adapt the operation of the logic inputs to the technology of the programmable controller outputs.

- Set the switch to Source (factory setting) if using PLC outputs with PNP transistors.
- Set the switch to Ext if using PLC outputs with NPN transistors.

### Switch Set to SRC (Source) Position Using the Output Power Supply for the Digital Inputs

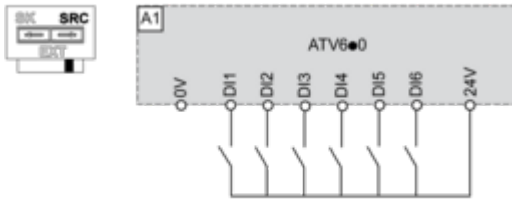

### Switch Set to SRC (Source) Position and Use of an External Power Supply for the DIs

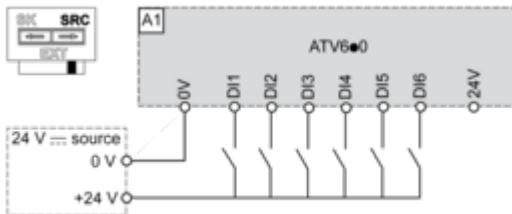

### Switch Set to SK (Sink) Position Using the Output Power Supply for the Digital Inputs

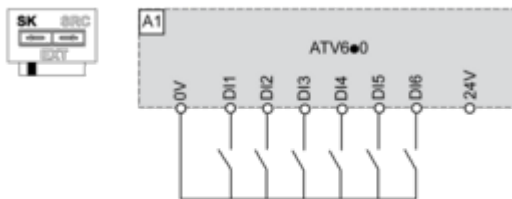

### Switch Set to EXT Position Using an External Power Supply for the DIs

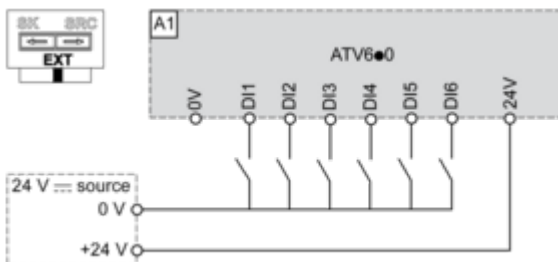

## Performance Curves

### Derating Curves

#### Normal Duty

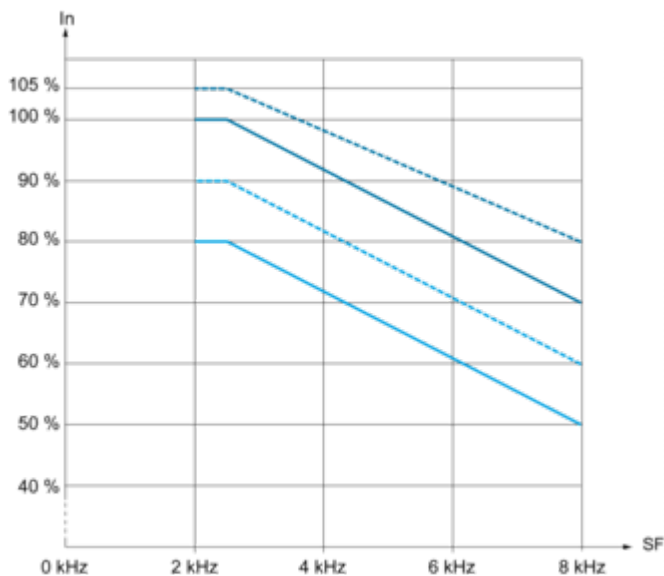

- 30 °C (86 °F)
- 40 °C (104 °F)
- - - - - 45 °C (122 °F)
- 50 °C (140 °F)

In : Nominal Drive Current  
 SF : Switching Frequency

#### Heavy Duty

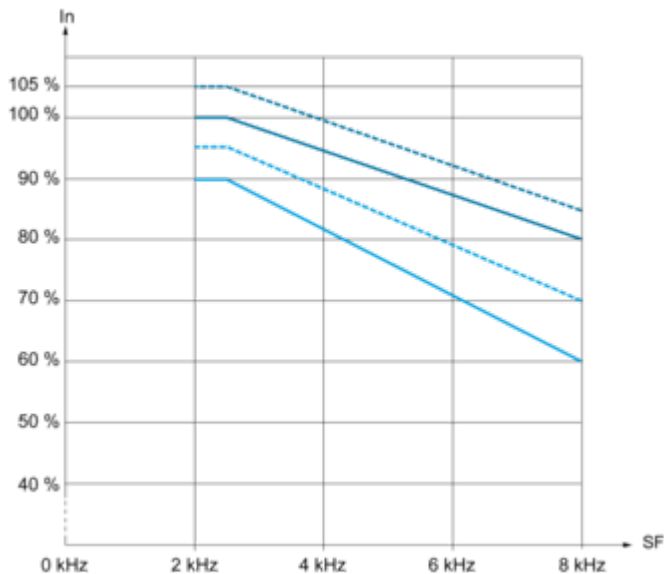

- 30 °C (86 °F)
- 40 °C (104 °F)
- - - - - 45 °C (122 °F)
- 50 °C (140 °F)

In : Nominal Drive Current  
 SF : Switching Frequency

